

**IHDE**DENTAL 

TWO PIECE IMPLANTS  
DENTAL IMPLANT  
SYSTEM  
**S-SYSTEM**



"FOR ME, IMPLANTOLOGY BEGINS  
WHERE OTHERS HAVE GIVEN UP."

- Dr. Stefan Ihde



Dr. Ihde Dental has been a reliable partner for over 60 years providing a wide range of implant systems and consumables. We supply dentists and dental technicians with precisely coordinated materials and systems, which are easy and reliable to use. We always ensure high quality and an excellent price-performance ratio so that you can guarantee allround treatment for your patients that is cost-effective and highly efficient. The following catalog gives you an overview and all the essential information about our implant systems. You can also contact us personally any time using the phone numbers provided. Further information can be found on our websites:

[www.ihde.com](http://www.ihde.com) || [www.ihde-dental.de](http://www.ihde-dental.de) || [www.ihde.com](http://www.ihde.com)

**The company** was founded in 1954 in Berlin by the dental technician Klaus Ihde. The company relocated to Bavaria in the 1960s. At the end of the 1980s, Dr. Ihde Dental GmbH (Germany) and Dr. Ihde Dental AG (Switzerland) were formed from the Klaus Ihde retail company. Ihde Dental is now represented in four locations in Europe and over 45 countries. The company group is one of the most innovative implant companies in the world – based on new developments and patents issued or pending.

**The core activities** of Ihde Dental are the development, procurement and distribution of medical products. We use a large number of suppliers in consumables, but we have produced implants in our own factory for many years. All components are manufactured quickly, precisely and economically thanks to state-of-the-art production technology and well-equipped machinery.

#### **Our partners**

Users and customers provide us with many new ideas and excellent suggestions. Collaboration with our customers is extremely important to us. Contact us at any time if you have any improvements or questions. Your ideas and opinions help us all to meet the daily wishes of patients to a greater and better extent. We also put the needs of the patient first..

#### **Our market performance and work ethic**

Since it was founded, the company has focused on innovative ideas and advanced technology, premium quality, an excellent price-performance ratio, optimal patient and user friendly products and durability. Our range combines the latest findings from research and practices in many countries around the world.

Customer orientated to us means – **available for you!**

- We provide training courses, refresher courses and user advice.
- We provide customers with comprehensive and technically sound advice.
- We also visit you in your practice upon request.

**Please call us to arrange an appointment  
or send us an email.**

**IHDE**DENTAL 

**Dr. Ihde Dental AG**  
Dorfplatz 11  
CH - 8737 Gommiswald / SG  
Tel. +41 (0)55 293 23 23  
contact@implant.com

**Dr. Ihde Dental GmbH**  
Erfurter Str. 19  
D - 85386 Eching / Munich  
Tel. +49 (0)89 319 761-0  
Fax +49 (0)89 319 761-33  
info@ihde-dental.de

# THE ADVANTAGES

OF THE ENDOSSEOUS DENTAL IMPLANT SYSTEM **S-SYSTEMS**

**SSO**<sup>®</sup>, **STO**<sup>®</sup> and **STW**<sup>®</sup> implants consist of highly break-proof titanium alloy Ti6Al4V. **SSO**<sup>®</sup> is a successful implant with octagon socket and 8° inner cone for rotationally-secured suprastructures. The surface is roughened in the endosseous region. **STO**<sup>®</sup> is a precision conical implant with octagon socket and 8° inner cone. Compression screw thread for stable endosseous anchorage. For rotationally-secured suprastructures. **STW**<sup>®</sup> implants with internal octagon and 8° inner cone are for anti-rotation super-structures.

The prescribed or recommended tightening torques for implants, abutments and screws can be found on our website:

[www.implant.com/en/downloads](http://www.implant.com/en/downloads)



Secure rotation protection by precision inner octagon

Tightness due to 8° inner cone

Universal application for permanent and removable prosthodontics

Made of highly resistant titanium alloy

Smart instrument tray

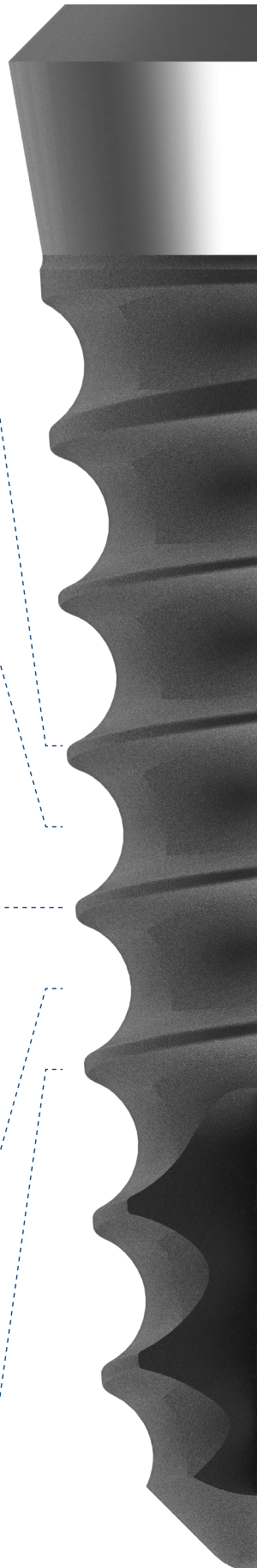

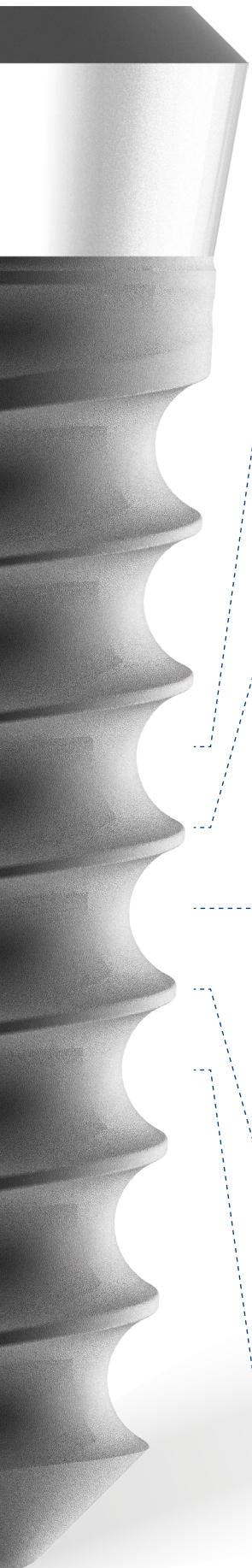

Internal octagon

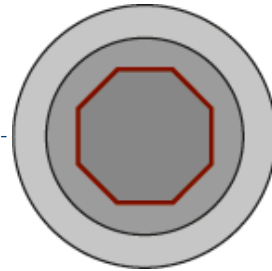

Wide range  
of sizes:

**SSO<sup>®</sup>**

Enossal length  
Enossal Ø

7 - 17 mm  
3.3 - 4.8 mm



**STO<sup>®</sup>**

Enossal length  
Enossal Ø

7 - 15 mm  
3.7 - 4.8 mm

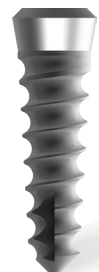

**STW<sup>®</sup>**

Enossal length  
Enossal Ø

9 - 15 mm  
4.8 mm

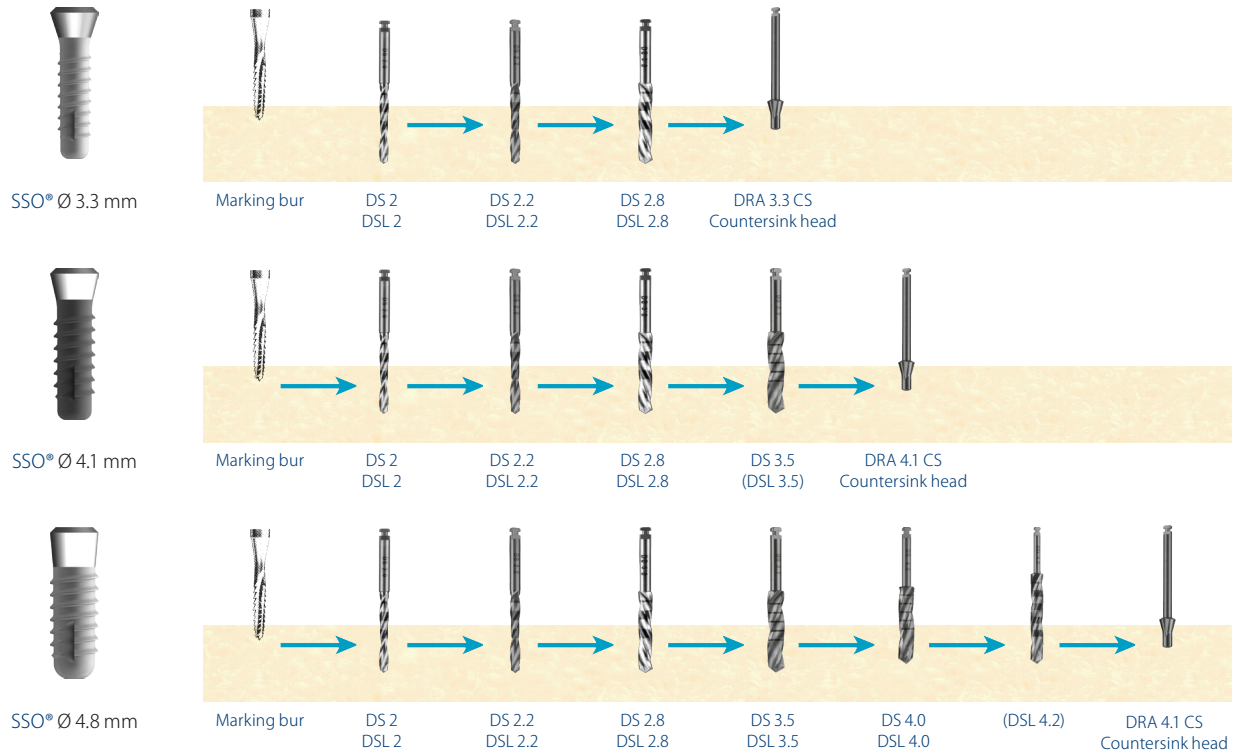
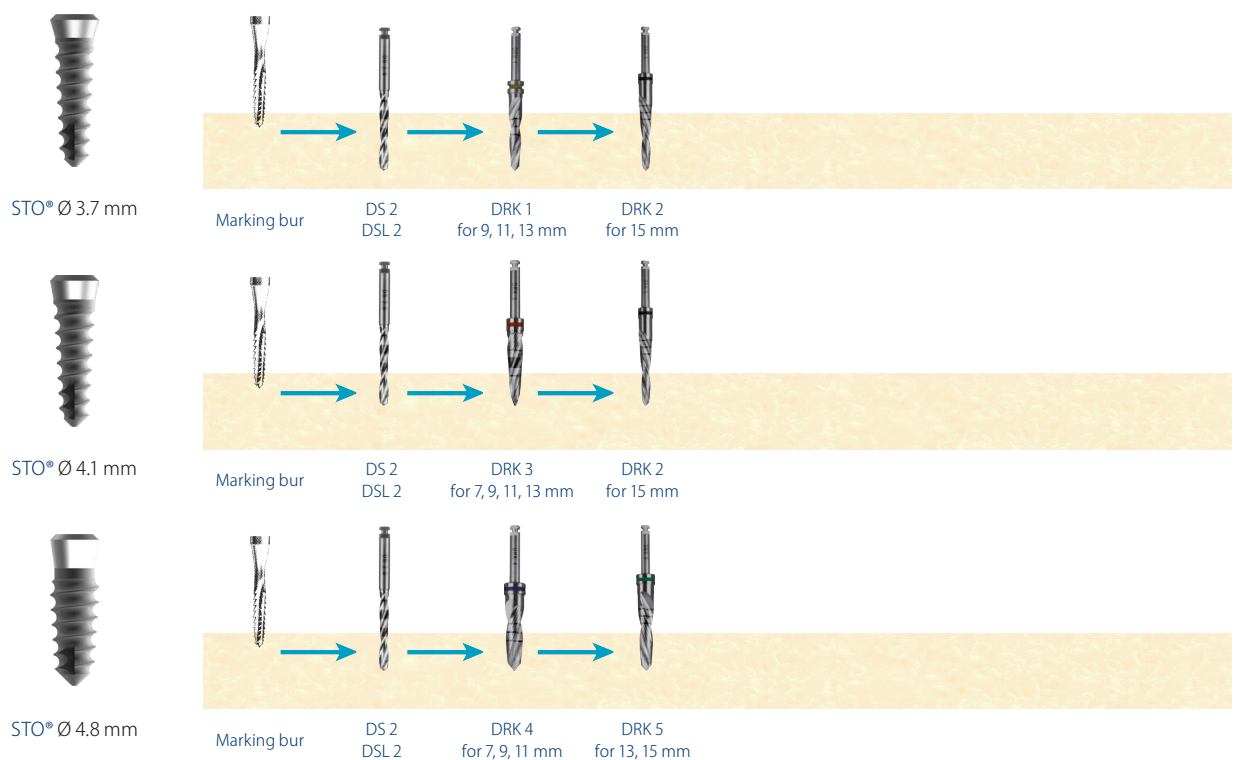

## SURGERY

1.1a. Recommended drill sequences for **SSO**<sup>®</sup> implants1.1b. Recommended Drill Sequences for **STO**<sup>®</sup> implants

## 1.2 Tap for lower jaw (only for use with SSO®)

TAP 1	Size 3.3 (for implants Ø 3.3 mm)
	Size 4.1 (for implants Ø 4.1 mm)
	Size 4.8 (for implants Ø 4.8 mm)

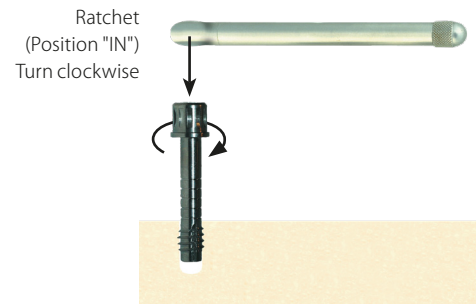

## 2. Implant packaging SSO® / STO®



Original packaging



Open package using the flap.  
Remove the label and stick it into  
your patient's record.



The opened package contains the  
implant in a sterile tube (primary  
package).

## 3. Removing the implant from the sterile tube

1. Open the lid. The implant is connected to the lid through a breakable section.
2. Remove the implant without touching the inner walls of the tube.

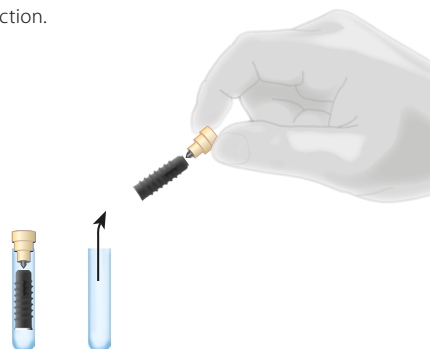

## 4. Handling

### Assembling the placement aid

Attach the insertion tool to the implant (SSO or STO) by holding the Lid, to which the implant is secured, with your other hand.

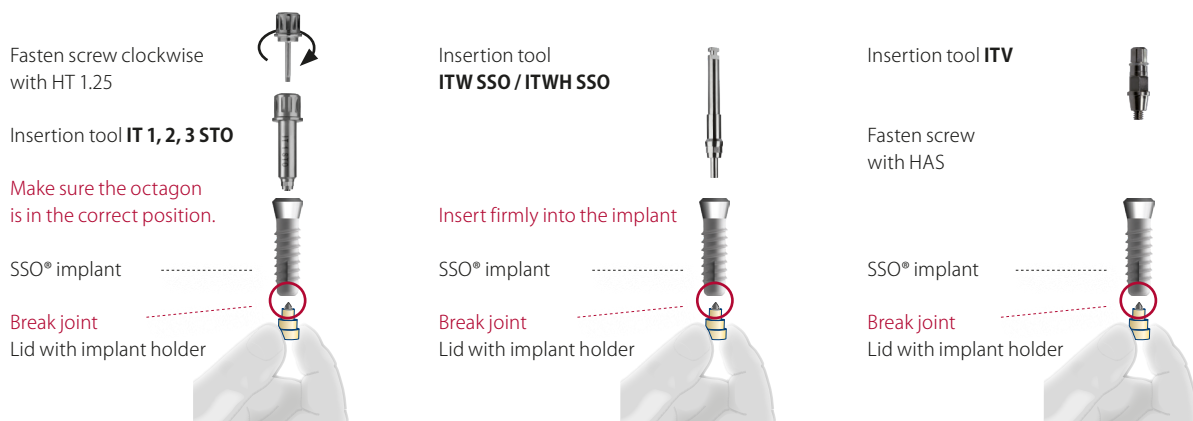

After you have attached the insertion tool, firmly hold the lid in your hand and break the implant off the lid. Insert the implant manually until it fits tightly into the jaw.

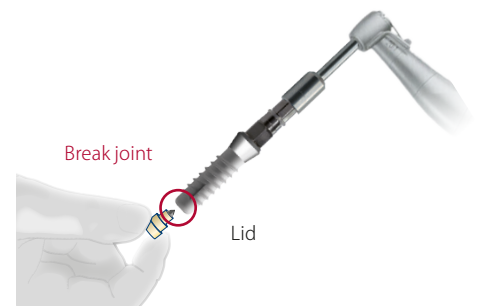

## 5. Insertion

Using the ratchet or contra-angle handpiece: screw the implant clockwise into the bone cavity. The endosseous part of the implant must be **completely** covered by the bone. The polished implant neck is located partially outside of the bone or at bone level. We recommend to screw min. 1 mm of the polished implant neck inside of the bone.





## 6. Remove insertion tool from implant

Release of the insertion tool or the contra-angle handpiece from the implant:

Using HT 1.25 loosen the screw in the insertion tool. Pull insertion tool off the implant and separate while loading the insertion tool IT STO in insertion from the contra-angle hand piece. direction with the ratchet.

Attach IT ITV Ratchet adapter with RAT2 ratchet to the ITV insertion tool. Using the HAS flat wrench firmly hold the lower hexagon of the ITV. Remove the ITV from the implant using the ratchet ("Out" position).



## 6. Result

The implant is fully inserted and ready for healing.



## 8. Post-operative treatment

Close the implant with a cover screw CST STI (tool: HT 1.25)

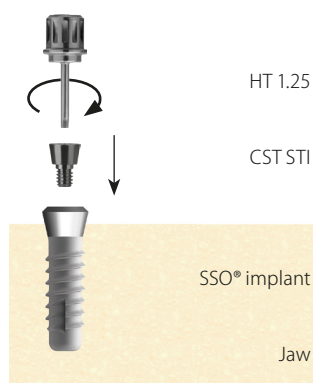

After the healing period: Remove cover screw

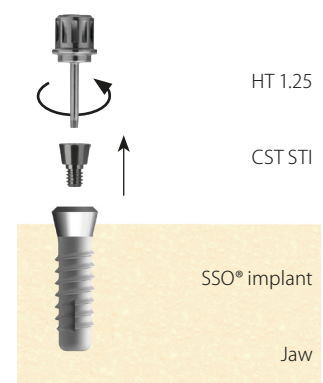

## 9. Impression taking

### 9.1 Impression taking with perforated, individual impression tray

The long pick up screw must be clearly visible, when the impression tray is inserted over the impression post.

The impression material must be removed in the area of the screw access prior to hardening.

### 9.2 Prior to impression taking

Impression taking with an A silicone® such as Safepprint®.

The use of open or closed impression trys is possible.

### 9.3 Impression taking

Remove OLT STO from the implant. OLT STO remains in the impression.

### 9.4

View of the impression post OLT STO in the impression (Pick up method)

### 9.5

After the impression is taken, the implant is closed with a healing screw (HS) and the impression is sent to the laboratory.

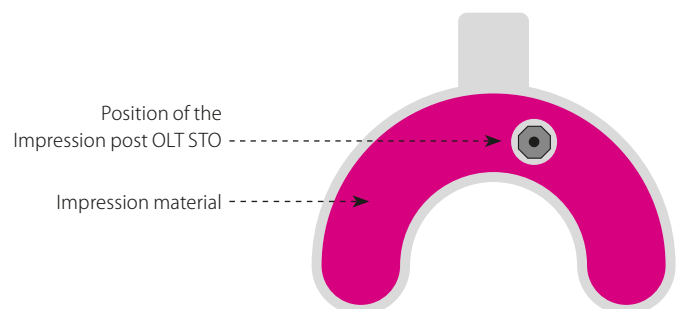
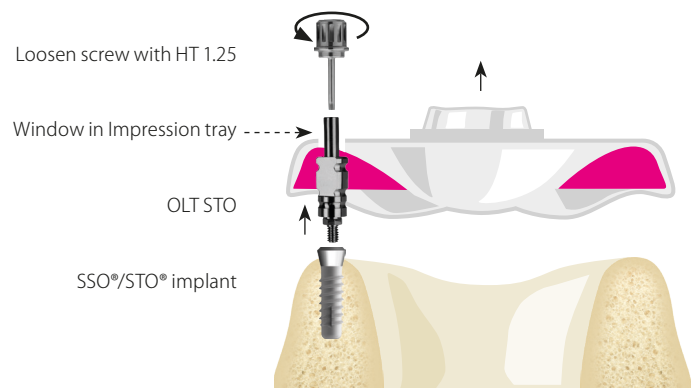
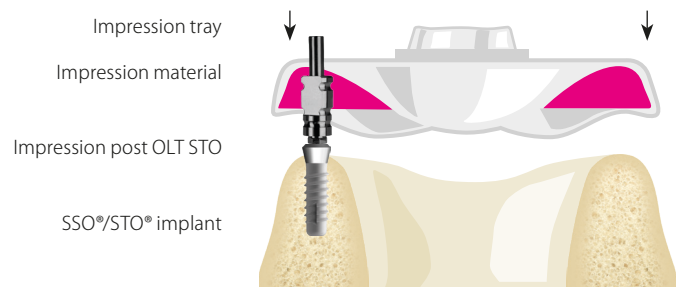
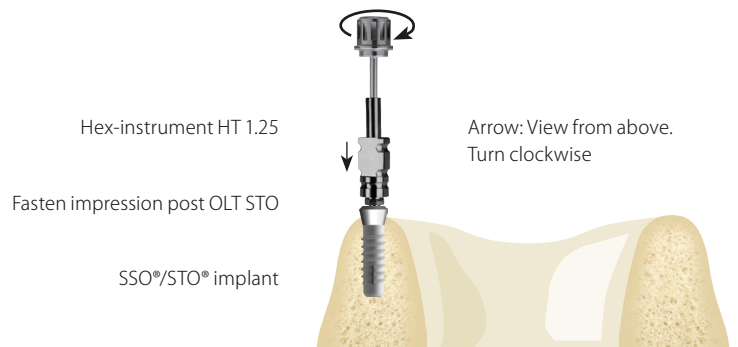

## 10. Further processing in the laboratory

### 10.1

Screw IA STO against the impression post.

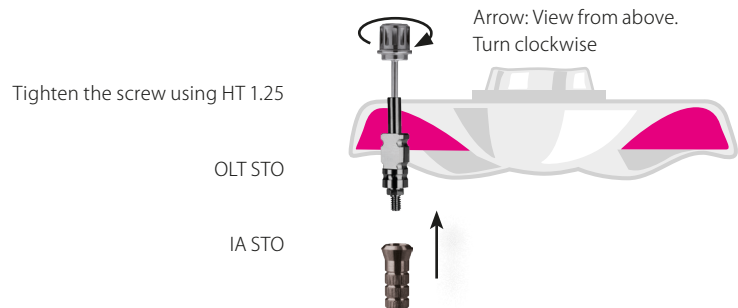

### 10.2

The impression is casted. Then the transfer OLT STO is unscrewed from the laboratory analogue IA STO.

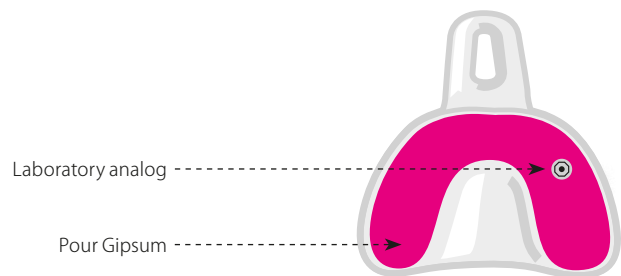

### 10.3

The laboratory analogue is now in the proper position and orientation in the putty.



### 10.4

Positioning the solid secondary part TLA STO (straight) or angulated TLA15 STO, TLA20 STO or TLA25 STO, at which the optimal position and adequate angulation must be determined.

#### Note

The octagon must be completely entered into the analogue. Ensure correct position of the octagon.



### 10.5

Ensure proper position of the abutment when transferring into the mouth. Tightening torque of the screw during fastening on the implant with: 25 Ncm.

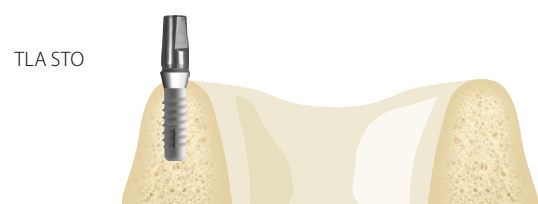

## SSO® IMPLANTS

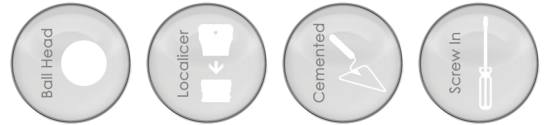

Successful implant with octagon socket and 8° inner cone. Connection type: Inner cone + internal octagon / head-Ø: 4.8 mm. Made from titanium alloy ASTM F 136-13/ISO 5832- 3. For rotationally-secured supra-structures. Surface is roughened in endosseous region.

		Description	Enossal Ø	Enossal length	REF	Price cat.	
		SSO 3.3 9	3.3 mm	9 mm	420000	F	
		SSO 3.3 11	3.3 mm	11 mm	420001	F	
		SSO 3.3 13	3.3 mm	13 mm	420002	F	
		SSO 3.3 15	3.3 mm	15 mm	420003	F	
		SSO 4.1 7	4.1 mm	7 mm	420004	F	
		SSO 4.1 9	4.1 mm	9 mm	420005	F	
		SSO 4.1 11	4.1 mm	11 mm	420006	F	
		SSO 4.1 13	4.1 mm	13 mm	420007	F	
		SSO 4.1 15	4.1 mm	15 mm	420008	F	
		SSO 4.1 17	4.1 mm	17 mm	420009	F	
	a) Head Ø	4.8 mm	SSO 4.8 7	4.8 mm	7 mm	420010	F
	b) Aesthetic head	1.8 mm	SSO 4.8 9	4.8 mm	9 mm	420011	F
	c) Enossal length	7 - 17 mm	SSO 4.8 11	4.8 mm	11 mm	420012	F
	d) Enossal Ø	3.3 / 4.1 / 4.8 mm	SSO 4.8 13	4.8 mm	13 mm	420013	F



Delivery incl. surgical screw CST STI

**NOTE IN CONTRAINDICATIONS** implants made from c.p. titanium are in general less force resistant compared to those made from titanium alloy. implants having a nominal diameter of less than 3.8 mm are not indicated for single tooth replacement, independently if they are made from c.p. titanium or from titanium alloy. implants Typ STO 3.7 and SSO 3.3 should be used as supporting implants.

STO 3.7 mm and SSO 3.3 mm implants may not be used in the molar region and not as single tooth implants with off axis load. STO 3.7 mm and SSO 3.3 mm implants are used as supporting implants, for example to increase the number of abutments in immediate load situation. Never use STO 3.7 mm and SSO 3.3 mm implants when cantilevers are involved. STO 3.7 and SSO 3.3 are not for single tooth replacement.

**Note the following contra-indications:**

STO 3.7, SSO 3.3: Do not use in areas where off-axis load is present. Do not use in areas with strong chewing forces. Do not use in flexion areas of the jaws.

## STO® IMPLANTS

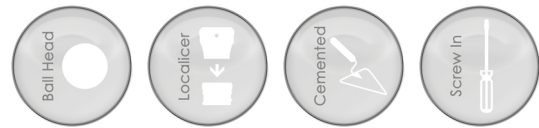

Precision conical implant with octagon socket and 8° inner cone. Octagonal system. Connection type: Inner cone + internal octagon / head-Ø: 4.8 mm. Strengthened titanium alloy (Ti6Al4V) according to ASTM F 136/ISO 5832-3 or Ti6 Al7 Nb. Compression screw thread and internal cone 8° for stable endosseous anchorage

		Description	Enossal Ø	Enossal length	REF	Price cat.	
		STO 3.7 9	3.7 mm	9 mm	420020	F	
		STO 3.7 11	3.7 mm	11 mm	420021	F	
		STO 3.7 13	3.7 mm	13 mm	420022	F	
		STO 3.7 15	3.7 mm	15 mm	420023	F	
		STO 4.1 7	4.1 mm	7 mm	420024	F	
		STO 4.1 9	4.1 mm	9 mm	420025	F	
		STO 4.1 11	4.1 mm	11 mm	420026	F	
		STO 4.1 13	4.1 mm	13 mm	420027	F	
		STO 4.1 15	4.1 mm	15 mm	420028	F	
		STO 4.8 9	4.8 mm	9 mm	420030	F	
		STO 4.8 11	4.8 mm	11 mm	420031	F	
		STO 4.8 13	4.8 mm	13 mm	420032	F	
		STO 4.8 15	4.8 mm	15 mm	420033	F	
	a) Head Ø	4.8 mm					
	b) Aesthetic head	1.8 mm					
c) Enossal length	7 - 15 mm						
d) Enossal Ø	3.7 / 4.1 / 4.8 mm						



Delivery incl. surgical screw CST STI

## SURGICAL ACCESSORIES FOR SSO®, STO®

	Description	Code	REF	Price cat.
	Cover screw. Tighten with <b>HT 1.25</b>	CST STI	420300	A
	For 2 mm gingival height, cylindrical	HS2 STI	420301	B
	Gingivaformer Tighten with <b>HT 1.25</b>	HS4 STI	420302	B
	For 5 mm gingival height, anatomical	HS5 STI	420303	B





## TEMPBASE® ABUTMENTS FOR PROVISIONAL RESTORATIONS

Temporary basis for SSO and STO. With anti-rotation, PEEK, individually grindable. For cemented crowns and bridges. Tighten with **HT 1.25**.

	TempBase® for SSO®, STO®, 2 mm gingival height, incl. screw	TPB 2 SSO	420304	D
	TempBase® for SSO®, STO®, 4 mm gingival height, incl. screw	TPB 4 SSO	420305	D

**ABUTMENTS FOR CEMENTED PROSTHETICS FOR SSO®, STO®**

With octagon. Anti-rotation, screw-in abutment with pre-assembled screw for cemented crowns or bridges.. Tighten with **TT 1.25**.

	Description	Code	REF	Price cat.
	Straight abutment, 6 mm height above implant	TLA STO	420306	D
	15° angled. The angulation runs axial <b>above the edge</b> of the octagon	TLA15 STO	420307	E
	15° angled. The angulation runs axial <b>above the area</b> of the octagon Metalic-yellow	TLA15F STO	420308	E
	20° angled. The angulation runs axial <b>above the edge</b> of the octagon	TLA20 STO	420309	E
	25° angled. The angulation runs axial <b>above the edge</b> of the octagon	TLA25 STO	420311	E
	25° angled. Die angulation runs axial <b>above the area</b> of the octagon Metalic-yellow	TLA25F STO	420312	E

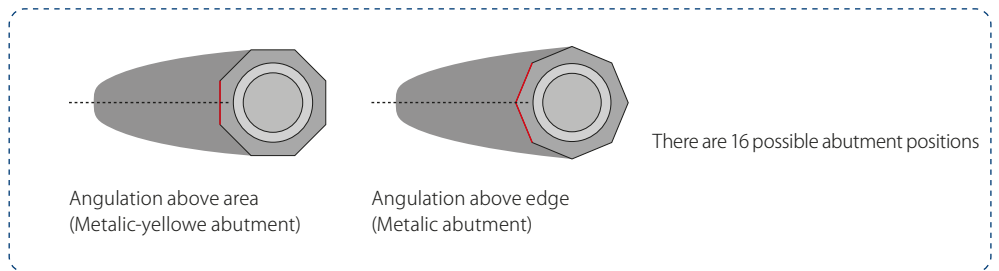

Description	OLT STO	IA STO	PS	PS 15	PS 20	PS 25
Impression post With Pick-Up screw		Lab analogue Inner octa	Synthetic base Castable 7.4 mm high TLA STO	Synthetic base Castable 4 mm high TLA15 STO	Synthetic base Castable 4 mm high TLA20 STO	Synthetic base Castable 4 mm high TLA25 STO
<b>Code</b>	OLT STO	IA STO	PS	PS 15	PS 20	PS 25
<b>REF</b>	420350	420348	420354	420355	420356	420357
<b>Price cat.</b>	B	B	A	A	A	A

Description	Unit	Code	REF	Price cat.
Replacement screw for OLT STO, long	1 piece	SF 767	SF 767	B

<b>ALTERNATIVE</b>	Screw SF OLT, short, 14.5 mm for OLT STO	1 piece	SF OLT	420909	B
--------------------	--	---------	--------	--------	---

With cone (without anti-rotation). One piece abutment with solid thread.



#### Description

For cemented crowns and bridges. Height above implant 6 mm  
8° incline. Can be shortened or trimmed. Flat on one side  
Direct impression or transfer to laboratory analogue IA STI  
Tighten with **HT 1.25**

#### Code

TCA STI

#### REF

420313

#### Price cat.

D



#### Description

Impression post  
9 mm high

Impression post  
13 mm high

Lab analogue  
With conus

Plastic base,  
Castable, 7.4 mm

#### Code

TS STI

TSX STI

IA STI

PS

#### REF

420345

420411

420347

420354

#### Price cat.

B

B

B

A

## SOLID ABUTMENTS



#### Description

Flat on one side for increased  
rotation stability, 6° Incline  
Tighten with **IT TCA**

#### Height above implant

4 mm

5.5 mm

7 mm

#### Colour

yellow

grey

blue

#### Code

SA4 STI

SA5 STI

SA7 STI

#### REF

420318

420319

420320

#### Price cat.

C

C

C

**Tightening torque 30 Ncm.** For the impression taking on the abutment use:



#### Description

Colour coded transfer post  
for SA-abutments

Use with **REF 460230**

Abutment analogue

Use with TZ SA4, 5, 7

Castable abutment  
10 mm high, reducible

Anti-rotation (PA SA)  
Internally round (PA SR)

Gingiva retractor,  
Pack of 4

Use instead of retraction cord

#### Code

TZ SA4, 5, 7

AA SA4, 5, 7

PA SA/ PA SR

#### REF

420404, 420405,  
420406

420324, 420325, 420326

420327, 420328

460230

#### Price cat.

A

B

A

B

With cone (without anti-rotation). Single-piece abutments with fixed thread and vertical cement escape grooves.

	Description	Height above implant	Colour	Code	REF	Price cat.
	6° incline Tighten with <b>ITTCA</b>	4 mm	yellow	<b>TCA4 STI</b>	<b>420415</b>	C
		5.5 mm	grey	<b>TCA5 STI</b>	<b>420416</b>	C
		7 mm	blue	<b>TCA7 STI</b>	<b>420417</b>	C

**Tightening torque 30 Ncm.** The impression taking is carried out on the abutment directly.



Description	Abutment analogue Use with TCA 4	Abutment analogue Use with TCA 5	Abutment analogue Use with TCA 7	Castable abutment 10 mm high Reducible, white
<b>Code</b>	<b>AA TCA 4</b>	<b>AA TCA 5</b>	<b>AA TCA 7</b>	<b>PA TCA</b>
<b>REF</b>	<b>420407</b>	<b>420408</b>	<b>420409</b>	<b>420332</b>
<b>Price cat.</b>	<b>B</b>	<b>B</b>	<b>B</b>	<b>A</b>

## ABUTMENTS FOR SCREW-IN PROSTHETICS

	Description	Code	REF	Price cat.
	<b>With outer octagon and octagon</b> Abutment with double threaded screw and octagon for crowns, bridges and bases. Anti-rotation anchorage of the prosthetics and to the implant. Height above implant 1.5 mm. Tighten with <b>HT 1.25</b>	<b>OSA STO</b>	<b>420337</b>	<b>E</b>
	<b>With outer octagon and conus</b> <b>Singel piece</b> , octagonal screw-in abutment for anti-rotational anchorage of the prosthetics. For crowns, bridges and bar connectors. Impression taking must be taken on the abutment. Height above implant 1.5 mm. Tighten with <b>HT 1.77 / HTX 1.77</b> . Tightening torque <b>30-35 Ncm</b>	<b>OSA STI</b>	<b>420338</b>	<b>D</b>



Description	Transfer post For OSA STO/STI	Screw For anchorage of TST STI	Lab analogue For OSA STO/STI	Castable abutment 10 mm high, pack of 5	Screw for fixation
<b>Code</b>	<b>TST STI</b>	<b>SF 365</b>	<b>OA STI</b>	Internally edged <b>PAOA</b>	Internally round <b>PAOR</b>
<b>REF</b>	<b>420339</b>	<b>420938</b>	<b>420340</b>	<b>420342</b>	<b>420343</b>
<b>Price cat.</b>	<b>B</b>	<b>B</b>	<b>B</b>	<b>B</b>	<b>B</b>
					<b>SF 350 or SF 365</b> <b>420930 or 420938</b>



## PROTECTION CAP FOR OSA STO AND OSA STI



### Description

Protection cap made of plastic, white  
Screwable and reducible  
For OSA STO or OSA STI, 3 mm high

Unit	Code	REF	Price cat.
Pack of 5	CSTO	420344	B

## CoCrMo BAR CONNECTER ELEMENTS



### Description

Bar coping made of CoCrMo for all S-implants  
Height above implant 5.5 mm  
Screw directly onto implant with SF 350 or SF 365

REF	Price cat.
SK C STI	C



Bar sleeve made of POM, castable, large  
3.0 mm high, 2.2 mm wide, 55 mm long

PA SP1	C
--------	---

## TITANIUM BAR MATRIX



### Description

Titanium bar matrix for PA SP1, 55 mm long

REF	Price cat.
SP6	C

## CONICAL CROWNS AND BRIDGES



### Description

Bur cylinder for bridges (internally round), height above implant 8 mm, 6 mm Ø  
Screw onto OSA STI or OSA STO with screw SF 350

REF	Price cat.
KKR	B



Bur cylinder for crowns (internal octagon), height above implant 5 mm, 7 mm Ø  
Screw onto OSA STI or OSA STO with screw SF 350

FZ 5	B
------	---



Bur cylinder for crowns (internal octagon), height above implant 7 mm, 7 mm Ø  
Screw onto OSA STI or OSA STO with screw SF 350

FZ 7	B
------	---

## TITANIUM BASE FOR CAD CAM

Titanium base for SSO and STO. Material Ti6Al4V, anti-rotation. Tighten with **TT 1.25**.



### Description

Height 3.9 mm above implant shoulder  
Incl. screw SF N62

Code	REF	Price cat.
MB4 SSO	463120	D

## RETENTIVE BALL ABUTMENTS

**Description**

Ball abutment fits all nylon caps  
Head Ø 2.5 mm, height above implant 3 mm  
Tighten with **HT 1.25**

**Code**

TB STI

**REF**

420361

**Price cat.**

D



Ball abutment fits zu nylon caps

Head Ø 2.5 mm, height above implant 3.6 mm  
Tighten with **Tool E** (alternatively with **HAS 2**)

TB3 STI

420363

D

## Impression taking with transfer post

## Direct impression taking

**Description**

Lab analogue

Transfer post

Tighten with **HT 1.25**

Ball analog

**Code**

IA STI

TS STI

IAB

**REF**

420347

420345

420566

**Price cat.**

B

B

C

## ACCESSORIES FOR BALLHEAD ABUTMENTS

**Description**

Nylon cap transparent, Pull-off force ca. 1200g  
(EXTERNAL PRODUCT)

**Unit**

Pack of 2

**Code**

NC

**REF**

465028

**Price cat.**

A1



Nylon cap pink, Pull-off force ca. 800g  
(EXTERNAL PRODUCT)

Pack of 2

NC 1

465029

A1



Nylon cap yellow, Pull-off force ca. 500g  
(EXTERNAL PRODUCT)

Pack of 2

NC 2

465030

A1



Green, strong Nylon caps R-NC  
With increased friction strength  
Only with reduced diameter ball  
≤ 2.3 mm

Pack of 2

R-NC

465034

A1



Pink, medium  
(EXTERNAL PRODUCT)

Pack of 2

R-NC 1

465033

A1



Orange, soft

Pack of 2

R-NC 2

465032

A1



Metal sleeve for all nylon caps  
(EXTERNAL PRODUCT)

H

465031

B

## RETENTIVE BALL ABUTMENTS

**Description**

Ball abutment fits gold cap GC  
Head Ø 2.3 mm, height above implant 3.4 mm  
Tighten with **Tool E** (alternatively with **HAS 2**)

**Code**

TB2 STI

**REF**

420362

**Price cat.**

D

**Impression taking with transfer post****Direct impression taking****Description**

Lab analogue with conus

Transfer post  
Tighten with **HT 1.25**

Ball analog

Gold cap

**Code**

IA STI

TS STI

IAB 2

GC

**REF**

420347

420345

420367

420366

**Price cat.**

B

B

C

upon request

## LOCALICER®

Abutment for removable prosthetics. We recommend a minimum of six implants per jaw and the use of a single denture as splint when using LOC abutments. Tighten with **HT 1.77**.

**Description**

LOCS 2.5

**Height**

2.5 mm

**REF**

420386

**Price cat.**

D

LOCS 4

4.0 mm

420385

D

## ACCESSORIES FOR LOCALICER®

**Description**

Analogue + impression set

**Code**

AA LOC

**REF**

462337

**Price cat.**

C

Set with 5 caps + 1 housing (EXTERNAL PRODUCT)

**Code**

NCS

**REF**

462338

**Price cat.**

D

**Pull-off force**

Yellow 600 g, Pink 1.200 g, Transparent 1.800 g, Violet 2.700 g  
Black has no retention and is designed for temporary solutions for up to one month

## STW® IMPLANTS



## OCTAGONAL SYSTEM

Implant with internal octagon and 8° Internal cone. For anti-rotation superstructures. Highly fracture resistant titanium alloy (Ti6Al4V) according to ASTM F 136 / ISO 5832-3.

These implants with a head diameter of 6.5 mm can be used, if adequate bone is available, for posterior single crowns with the width of one premolar in dentate and partially/fully edentulous ridges as for superstructures retained by bars and ball attachments.

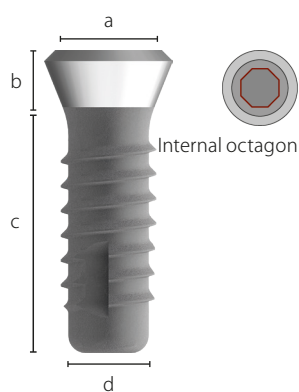
**Description**

STW 4.8 9  
STW 4.8 11  
STW 4.8 13

**Enossal Ø**

4.8 mm  
4.8 mm  
4.8 mm

**Enossal length**

9 mm  
11 mm  
13 mm

**REF**

420016  
420017  
420018

**Price cat.**

F  
F  
F

a) Head Ø	6.5 mm
b) Aesthetic head	1.8 mm
c) Enossal length	9 - 13 mm
d) Enossal Ø	4.8 mm

Delivery incl. surgical screw CST STW



## SURGICAL ACCESSORIES FOR STW®

**Description**

Cover screw. Tighten with **HT 1.25**

Gingivaformer  
Tighten with **HT 1.25**

For 2 mm gingival height  
Cylindrical

For 4 mm gingival height  
Cylindrical

**Code**

CST STW

HS2 STW

HS4 STW

**REF**

420370

420371

420372

**Price cat.**

B

B

B

## TITANIUM BASE FOR CAD CAM

**Description**

Titanium base for STW, Material Ti6Al4V, anti-rotation.  
Height 3.9 mm above implant shoulder.  
Incl. screw SF N62  
Tighten with **TT 1.25**

**Code**

MB4 STW

**REF**

463121

**Price cat.**

D

## ABUTMENTS FOR CEMENTED PROSTHETICS FOR STW®

Anti-rotation screw- in abutment incl. screw, for cemented crowns and bridges. Tighten with **TT 1.25**



### Description

Straight abutment

### Code

TLA STW

### REF

420373

### Price cat.

D

15° angled abutment

The 15° line angle runs axially across the edge of the octagon

TLA15 STW

420374

E



### Description

Impression post with  
Pick-Up screw  
Tighten with **HT 1.25**

Lab analogue

Plastic base  
Castable  
For **TLA STW**

Plastic base  
Castable  
For **TLA15 STW**

### Code

OLT STW

IA STW

PA STW

PA15 STW

### REF

420351

420349

420359

420360

### Price cat.

B

B

A

A

### Description

Replacement screw for TLAs of all S-implants

### Code

SF TLA

### REF

420910

### Price cat.

B

Replacement screw for impression post OLT STW

SF 767

SF 767

B

### ALTERNATIVE

Screw SF OLT, short, 14.5 mm for OLT STW

SF OLT

420909

B

## SOLID ABUTMENTS



### Description

Flattened on one side for increased  
rotational stability  
6° angled  
Tighten with **HT 1.77**

### Height above implant

4 mm

### Code

SA4 STW

### REF

420375

### Price cat.

C

6 mm

SA6 STW

420376

C



### Description

Transfer post for  
SA6 abutment

Abutment analogue  
Brown anodized  
For **TZ SA6 STW**

Castable abutment

### Code

TZ SA6 STW

AA SA6 STW

PA STW

### REF

420377

420378

420359

### Price cat.

A

B

A

## RETENTIVE BALL ATTACHMENTS

**Description**

Ball abutment, fits all nylon caps  
Head Ø 2.5 mm  
Height above implantat 3 mm  
Tighten with **HT 1.25**

**Code**

TB3 STW

**REF**

420365

**Price cat.**

D



Ball abutment, fits all nylon caps  
Head Ø 2.5 mm  
Height above implantat 3.45 mm  
Tighten with **Tool E** (alternatively with **HAS 2**)

**Code**

TB3 STW

**REF**

420364

**Price cat.**

D

## Impression taking with transfer post

## Direct impression taking

**Description**

Lab analogue with conus

Transfer post

Tighten with **HT 1.25**

Ball analog

**Code**

IA STW

TS STW

IAB

**REF**

420349

420346

420566

**Price cat.**

B

B

C

## ACCESSORIES FOR BALLHEAD ABUTMENTS

**Description**

Nylon cap transparent, Pull-off force ca. 1200g  
(EXTERNAL PRODUCT)

**Unit**

Pack of 2

**Code**

NC

**REF**

465028

**Price cat.**

A1



Nylon cap pink, Pull-off force ca. 800g  
(EXTERNAL PRODUCT)

Pack of 2

NC 1

465029

A1



Nylon cap yellow, Pull-off force ca. 500g  
(EXTERNAL PRODUCT)

Pack of 2

NC 2

465030

A1



Green, strong Nylon caps R-NC  
With increased friction strength  
Only with reduced diameter ball  
≤ 2.3 mm

Pack of 2

R-NC

465034

A1



Pink, medium  
(EXTERNAL PRODUCT)

Pack of 2

R-NC 1

465033

A1



Orange, soft

Pack of 2

R-NC 2

465032

A1







Metal sleeve for all nylon caps  
(EXTERNAL PRODUCT)

H

465031

B

## DRILL SEQUENCES CYLINDRICAL IMPLANTS

Implants	Enossal Ø	recommended drill sequences
 SSO°	3.3 mm	DS 2 425001 → DS 2.2 425003 → DS 2.8 425005 → DRA 3.3 CS 425046
		DSL 2 425002 → DSL 2.2 425004 → DSL 2.8 425006 → DRA 3.3 CS 425046
 SSO°	4.1 mm	DS 2 425001 → DS 2.2 425003 → DS 2.8 425005 → DS 3.5 425009 → DRA 4.1 CS 425047
		DSL 2 425002 → DSL 2.2 425004 → DSL 2.8 425006 → (DLS 3.5) 425010 → DRA 4.1 CS 425047
 SSO°	4.8 mm	DS 2 425001 → DS 2.2 425003 → DS 2.8 425005 → DS 3.5 425009 → DS 4.0 425011 → (DS 4.2) 425013 → DRA 4.1 CS 425047
		DSL 2 425002 → DSL 2.2 425004 → DSL 2.8 425006 → DLS 3.5 425010 → DSL 4.0 425012 → (DSL 4.2) 425014 → DRA 4.1 CS 425047
 STW°	4.8 mm	DS 2 425001 → DS 2.2 425003 → DS 2.8 425005 → DS 3.5 425009 → DS 4.0 425011 → (DSL 4.2) 425014 → DRA 4.8 CSW 425048
		DSL 2 425002 → DSL 2.2 425004 → DSL 2.8 425006 → DSL 3.5 425010 → DSL 4.0 425012 → (DSL 4.2) 425014 → DRA 4.8 CSW 425048

## DRILL SEQUENCES CONICAL IMPLANTS

Implants	Enossal Ø	Length in mm	recommended drill sequences
 STO°	3.7 mm	9 / 11 / 13	DS 2 425001 → DS 2.2 425003 → DRK 1 425020 → DRA 3.3 CS 425046
			DSL 2 425002 → DSL 2.2 425004 → DRK 1 425020 → DRA 3.3 CS 425046
 STO°	4.1 mm	15	DS 2 425001 → DS 2.2 425003 → DRK 2 425021 → DRA 3.3 CS 425046
			DSL 2 425002 → DSL 2.2 425004 → DRK 2 425021 → DRA 3.3 CS 425046
 STO°	4.8 mm	7 / 9 / 11 / 13	DS 2 425001 → DS 2.2 425003 → DRK 3 425022 → DRA 4.1 CS 425047
			DSL 2 425002 → DSL 2.2 425004 → DRK 3 425022 → DRA 4.1 CS 425047
 STO°	4.8 mm	15	DS 2 425001 → DS 2.2 425003 → DRK 2 425021 → DRA 4.1 CS 425047
			DSL 2 425002 → DSL 2.2 425004 → DRK 2 425021 → DRA 4.1 CS 425047
 STO°	4.8 mm	7 / 9 / 11	DS 2 425001 → DS 2.2 425003 → DRK 4 425023 → DRA 4.1 CS 425047
			DSL 2 425002 → DSL 2.2 425004 → DRK 4 425023 → DRA 4.1 CS 425047
 STO°	4.8 mm	13 / 15	DS 2 425001 → DS 2.2 425003 → DRK 5 425024 → DRA 4.1 CS 425047
			DSL 2 425002 → DSL 2.2 425004 → DRK 5 425024 → DRA 4.1 CS 425047

**PLEASE NOTE** that STO is by design a compression screw and a drill sequence can not be recommended for all bone qualities. In low density bone a smaller drill is recommended.

## GUIDE JACKET

**Description**

BFH 2.0 guide jacket 2.0 mmd

**Unit**

Pack of 5

**Material**

Ti6Al4V

**REF**

425410

**Price cat.**

B

BFH 2.5 guide jacket 2.5 mmd

Pack of 5

Ti6Al4V

425411

B

BFH 3.0 guide jacket 3.0 mmd

Pack of 5

Ti6Al4V

425412

B

BFH 3.2 guide jacket 3.2 mmd

Pack of 5

Ti6Al4V

425413

B

BFH 3.5 guide jacket 3.5 mmd

Pack of 5

Ti6Al4V

425414

B

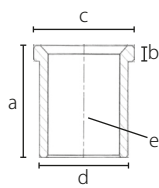

a) Length

5 mm

b) Height of step

0.7 mm

c) Max. Ø top

3.7 - 5 mm

d) Nominal Ø

3 - 4.4 mm

e) Ø of drilling in the drill template

2.05 - 3.55 mm



## PATHFINDER DRILLS

	Description	Type	Working length	REF	Price cat.
	BCD 1	non sterile	15 mm	900240	C
	BCDX 1	non sterile	15 mm	900243	C

## TWIST DRILL (EXTERNALLY IRRIGATED) FOR SSO®, STW®



Surgical steel, laser marked. Non sterile. For lifetime extension and consistent cutting performance and easy removal of contaminated areas. Maximum speed with external cooling 700 rpm. Drills can be used without cooling at 50 rpm on green contra-angle handgrip.

These drills are made of premium material using state-of-the-art precision milling machines. The benefit for you and your patients: Extremely good and durable cutting performance due to sophisticated geometry of the blades.

	Description	Length	Working length	Drill Ø	REF	Price cat.
	DS 2	32.5 mm	17 mm	2 mm	425001	D
	DS 2.2	36.5 mm	18 mm	2.2 mm	425003	D
	DS 2.8	36.5 mm	18 mm	2.8 mm	425005	D
	DS 3.2	36.5 mm	18 mm	3.2 mm	425007	D
	DS 3.5	36.5 mm	18 mm	3.5 mm	425009	D
	DS 4.0	36.5 mm	18 mm	4.0 mm	425011	D
	DS 4.2	36.5 mm	18 mm	4.2 mm	425013	D
	DSL 2	45.5 mm	27 mm	2 mm	425002	D
	DSL 2.2	45.5 mm	27 mm	2.2 mm	425004	D
	DSL 2.8	45.5 mm	27 mm	2.8 mm	425006	D
	DSL 3.2	45.5 mm	27 mm	3.2 mm	425008	D
	DSL 3.5	45.5 mm	27 mm	3.5 mm	425010	D
	DSL 4.0	45.5 mm	27 mm	4.0 mm	425012	D
	DSL 4.2	45.5 mm	27 mm	4.2 mm	425014	D

## HEATLESS® DRILLS DRK FOR STO® IMPLANTS

Form drills made from surgical steel (SS), length and color coded, resterilizable. Note the information in the **Instructions for Use** for hygiene and preparation requirements with medical products intended for multiple use in implantology. Pilot drilling using DS 2, DSL2 or Pathfinder (see previous page).

	Description	System	Colour	Length	Implantat Ø	REF	Price cat.
	DRK 1	STO®	yellow	9, 11, 13 mm	3.7 mm	425020	D
	DRK 2	STO®	black	15, 17, 19 mm	3.7 / 4.1 mm	425021	D
	DRK 3	STO®	red	7, 9, 11, 13 mm	4.1 mm	425022	D
	DRK 4	STO®	blue	7, 9, 11 mm	4.8 mm	425023	D
	DRK 5	STO®	green	13, 15 mm	4.8 mm	425024	D
	DRK 6	STO®	metallic	21, 23, 25 mm	3.7 / 4.1 mm	425025	D

### IT HAS BEEN SCIENTIFICALLY PROVEN

**Heatless® drills by Dr. Ihde Dental generate 55% less heat** than traditional bone drills from other manufacturers. This makes it possible to use higher rotational speeds: between 3,000 and 5,000 rpm are recommended with good external cooling and intermittent drill technique.

## COUNTERSINK HEADS

	Description	System	Type	Implantat Ø	REF	Price cat.
	DRA 3.3 CS	SSO®	non sterile	3.3 mm	425046	D
	DRA 4.1 CS	SSO®, STO®	non sterile	4.1 mm	425047	D
	DRA 4.8 CSW	STW®	non sterile	4.8 mm	425048	D

## TAP (MADE OF CRONIDUR) FOR SSO®, STW®

	Description	Finish	Length	Implantat Ø	REF	Price cat.
	TAP1 3.3	9-17 mm	34 mm	3.3 mm	425055	D
	TAP1 4.1	9-17 mm	34 mm	4.1 mm	425056	D
	TAP1 4.8	9-17 mm	30 mm	4.8 mm	425057	D
	TAP2 3.3	9-17 mm	23 mm	3.3 mm	425058	D
	TAP2 4.1	9-17 mm	23 mm	4.1 mm	425059	D

## DRILLSTOP TRAY













Autoclaveable up to 134° C, not suitable for dry heat sterilizers.



Depth	Drillstop	
	DS	DSL
7	K	O
9	H	N
11	F	M
13	C	L
15	A	K
17		H
19		F
21		C
23		A

Description	REF	Price €
Drillstop A	500881	
Drillstop C	500883	
Drillstop F	500886	
Drillstop H	500888	
Drillstop K	500891	
Drillstop L	500892	
Drillstop M	500893	
Drillstop N	500894	
Drillstop O	500895	
Drill DS 2.8	425005	
Drill DS 3.2	425007	
Drill DS 3.5	425009	
Drill DS 4.0	425011	
Drill DS 4.2	425013	
Drill DSL 2.8	425006	
Drill DSL 3.2	425008	
Drill DSL 3.5	425010	
Drill DSL 4.0	425012	
Drill DSL 4.2	425014	
Tray with content	60034-K	upon request

## INSERTION TOOLS FOR SSO®, STO®, STW®

	Description	Type	Length	Index	For	REF	Price cat.
	IT1 STO	long	20 mm	HT 1.25		425060	K
	IT2 STO	short	12 mm	HT 1.25		425061	K
	IT3 STO	medium	16 mm	HT 1.25		425063	K
	ITW SSO	contra-angle	23 mm			463110	F
	ITWH SSO	contra-angle / hex	23 mm			463111	F
	This instrument is with an additional hex for force transmission to the contra-angle handpiece equipped. Fits to W&H contra-angle handpiece only.						
	ITV	short	11 mm		SSO, STO	500850	C
	IT ITV	Ratchet adapter			Adapter for ITV	500854	D
	Adapter	short / contra-angle	22 mm		ITV 500850	500851	D
	Adapter	long / contra-angle	32 mm		ITV 500850	500852	D
	Adapter	medium / contra-angle	27 mm		ITV 500850	500853	D
	HAS	square	85 mm		ITV	463108	H
	IT TCA	long	20 mm	direct	SA STI, TCA STI	425065	D
	Tool E	long	20 mm	direct	TB2 STI, TB3 STI, TB3 STW	462377	D

## INSTRUMENTS FOR SCREWS

	Description	Type	Length	Ø	Code	REF	Price cat.
	Hex instrument	long	21 mm	1.25 mm	HT 1.25	425100	C
	Hex instrument	long, for contra-angle	26 mm	1.25 mm	HT 1.25 M	425112	C
	Hex instrument	short	14 mm	1.25 mm	HTS 1.25	425101	C
	Hex instrument	extralong	45 mm	1.25 mm	HTX 1.25	425102	C
	Hex instrument	long	19 mm	1.77 mm	HT 1.77	425103	C
	Hex instrument	extralong	45 mm	1.77 mm	HTX 1.77	425104	C
	Hex instrument	long, for contra-angle	28 mm	1.77 mm	HT 1.77 M	425113	C
	Torx-Instrument	for SSO, STO and STW abutments	21 mm	1.25 mm	TT 1.25	425105	C

## TOOLS

	Description	Type	Code	REF	Price cat.
	Guide jacket	For pilot drill, Titanium 10 mm, 2.2 mm Ø. Pack of 5	BFH	425401	B
	X-ray measuring sphere	Surgical steel, Ø 5 mm Pack of 5	RM	425403	A
	Drill extension contra-angle	Extends by 19 mm	DX2	500704	D
	Punch	For contra-angle, 4.9 mm Ø	PUW1	425404	C
	Standardized probe	Scale 1 mm for radiographical measuring for cylindrical implant types, 22 mm	PDG	425400	A
	HAS	Flat spanner for ITV insertion tool, square-end, 85 mm	HAS	463108	H
	HAS 2	Flat spanner for ball attachments TB2 STI, TB3 STI and TB3 STW, 85 mm	HAS 2	463109	H
	Ratchet	For all Hex instruments and insertion tools, without torque	RAT 2	425051	K
	Torque wrench	Torque wrench 10 - 70 Ncm for all insertion tools, hex- and torx instruments	TW2	425402	S
	Universal adapter	For all contra-angle instruments Use with ratchet RAT 2. Max. 30 Ncm	UAW	425107	E

## STARTER TRAY

Autoclaveable up to 134° C, not suitable for dry heat sterilizers. This surgical kit contains all drills and tools for first works with the S-System.  
Material: autoclavable plastic.



Description	Code	REF	Price €
Insertion tool for ratchet	IT3 STO	425063	
Insertion tool for contra angle	ITWH SSO	463111	
Hex-instrument	HT 1.25	425100	
Torx instrument	TT 1.25	425105	
Pilot drill	BCD 1	900240	
Form drill	DS 2.2	425003	
Form drill	DS 2.8	425005	
Form drill	DS 3.5	425009	
Form drill	DS 4.2	425013	
Countersink head	DRA 4.1 CS	425047	
Standardized probe	PDG	425400	
Standardized probe	PDG	425400	
Torque wrench	TW2	425402	
<b>Starter tray with content</b>		<b>S60042-K</b>	<b>upon request</b>
<b>Starter tray w/o content</b>		<b>60042-K</b>	<b>upon request</b>



# IHDE DENTAL

(The products of this catalogue are CE marked (class I) and CE 1936 marked (class IIa and IIb) according to 93/42/EC Directive).

Commercial products that are not monitored by our notified body are declared as third-party products.

We are certified DIN EN ISO 13485, and annex II of EEC Directive 93/42 EWG (2007).

Due to technical reasons the product dimensions shown in this brochure might deviate from reality.

**SSO**<sup>®</sup>, **STO**<sup>®</sup> and **STW**<sup>®</sup> are registered trademarks.

In case that implants would be reprocessed (cleaned, resterilized) infections could occur, because no validated procedures for reprocessing are available.

## Compilation and explanation of symbols on the packaging:



Batch No.



Sterilized by  
gamma radiation



Non-sterile



Intended for use  
by dentists or  
surgeons only



Single use  
product



Instruction  
for use



Expiry date



Store  
in a dry  
place



Store tightly  
keep closed



Do not use if  
packing is  
damaged



Do not  
resterilize



Manufacturer



Production  
date



Catalogue  
number



Secure rotation protection by  
precision inner octagon and  
internal cone 8°

Reliable insertion - ease of use

Universal application for permanent  
and removable prosthodontics

**IHDE**DENTAL 

**Dr. Ihde Dental AG**  
Dorfplatz 11  
CH - 8737 Gommiswald / SG  
Tel +41 (0)55 293 23 23  
contact@implant.com  
www.implant.com

**Dr. Ihde Dental GmbH**  
Erfurter Str. 19  
D - 85386 Eching / Munich  
Tel +49 (0)89 319 761 0  
Fax +49 (0)89 319 761 33  
info@ihde-dental.de  
www.ihde-dental.de